

Data Sheet



Article number: 2304037231

Description: E+G Handle
M.443/200 N-CH

Measures

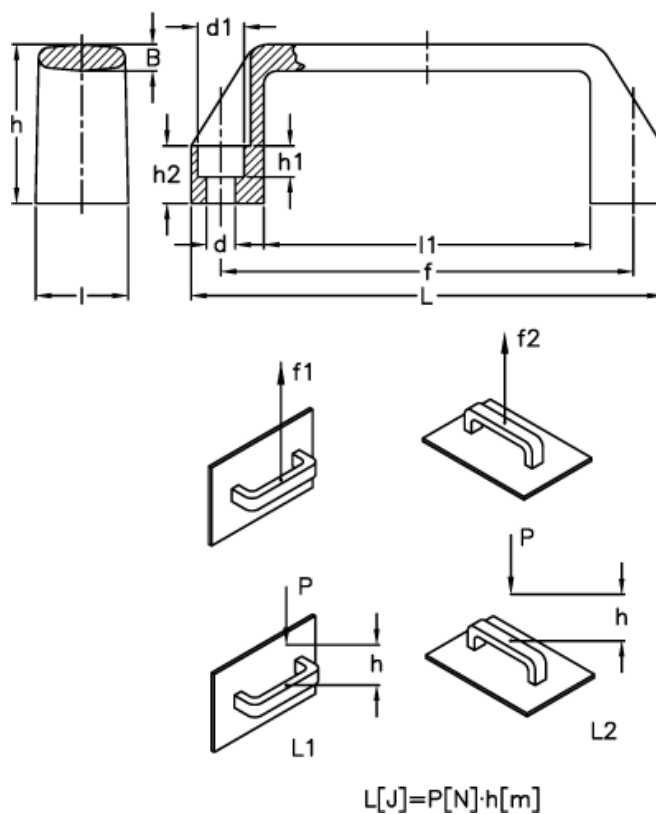

B	= 8	h2	= 17
d	= 8.5	l	= 28
d1	= 13.5	L	= 197
f	= 179 +/- 1	l1	= 153
F1 (N)	= 1800	L1 (J)	= 16
F2 (N)	= 1300	L2 (J)	= 8
h	= 50		
h1	= 8.5		